

# 4242 - HANDHOLE

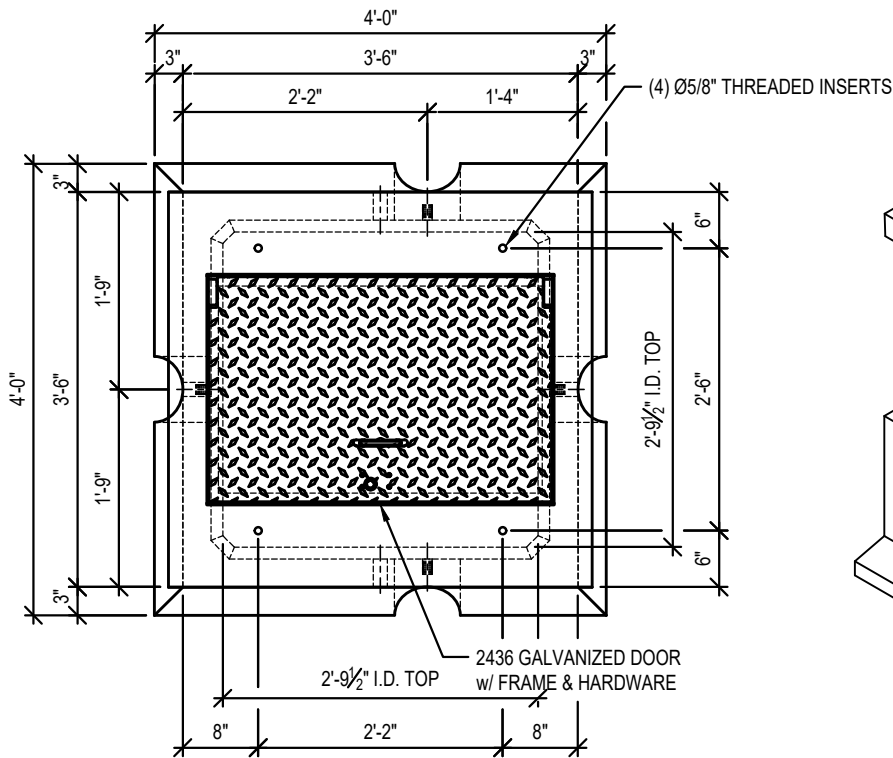

**PLAN VIEW**

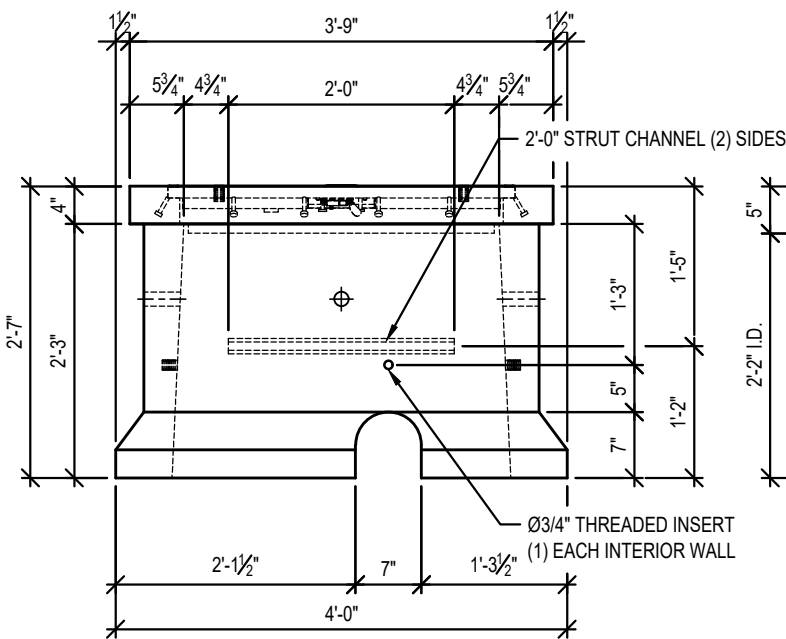
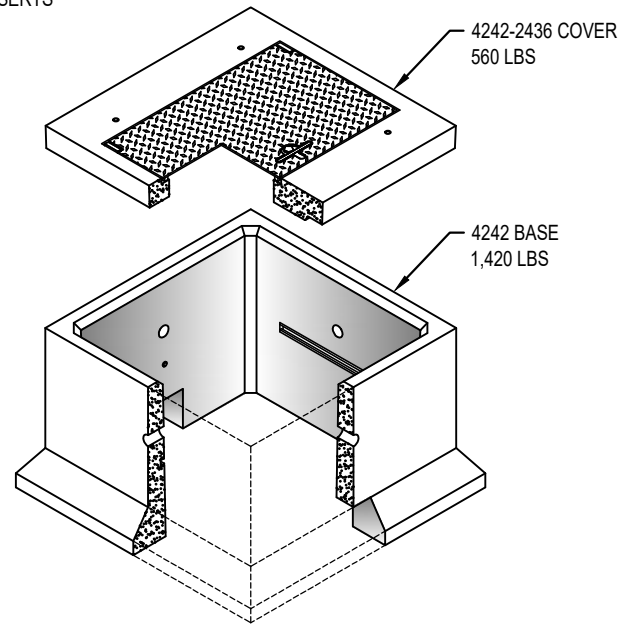

**SIDE VIEW**

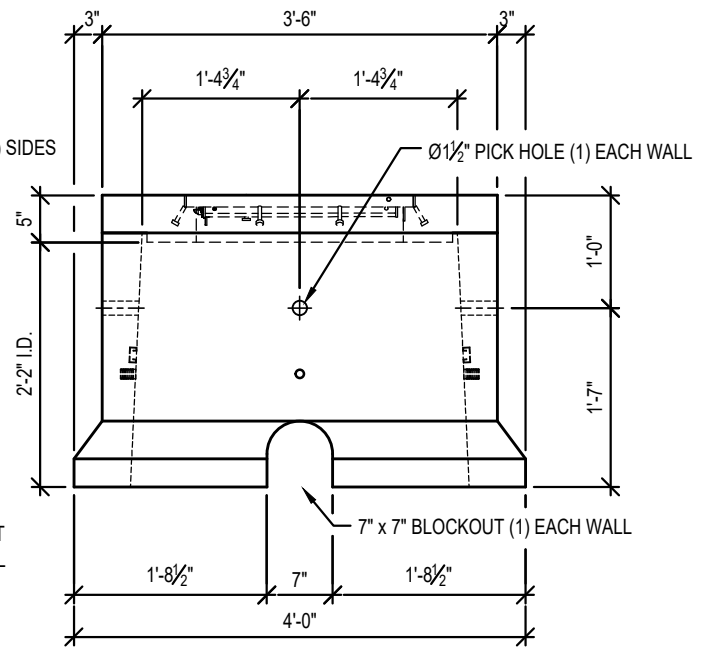

**END VIEW**