

PACIFIC CORP 575 SECT #7992607

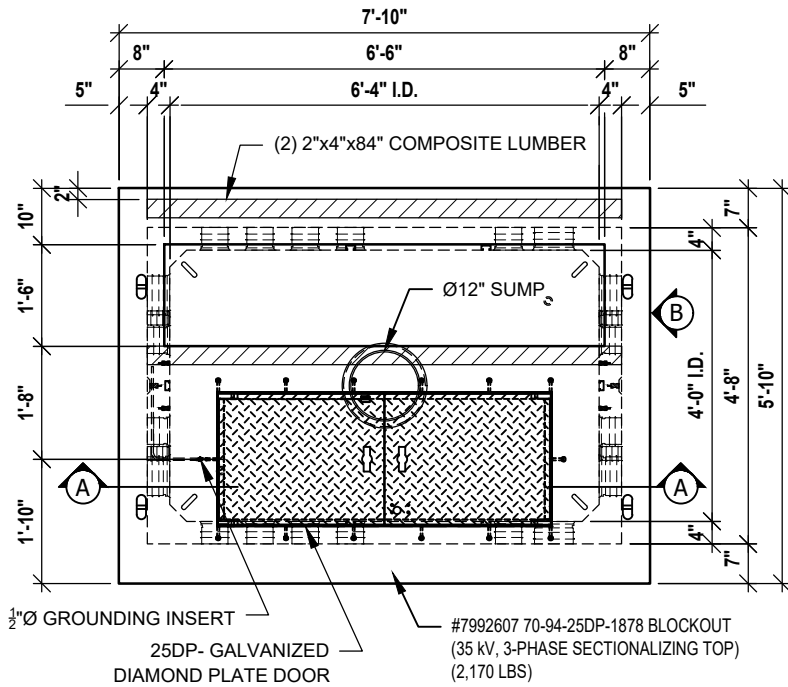

PLAN VIEW
SCALE: 3/8" = 1'-0"

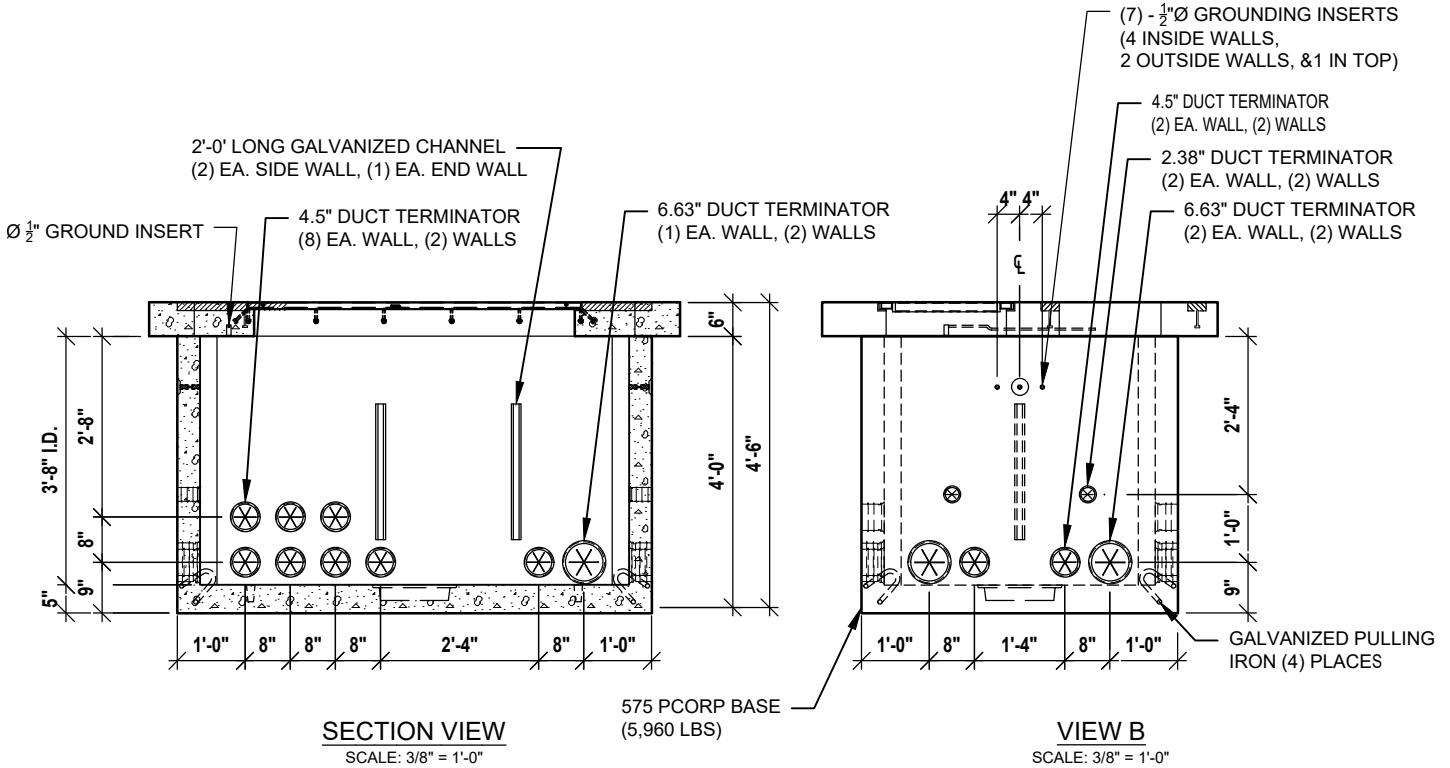

SECTION VIEW
SCALE: 3/8" = 1'-0"

VIEW B
SCALE: 3/8" = 1'-0"

NOTES:
1. WEIGHTS LISTED ARE APPROXIMATE.

PCORP ZG621 06-13-13