

# 3030 - HANDHOLE

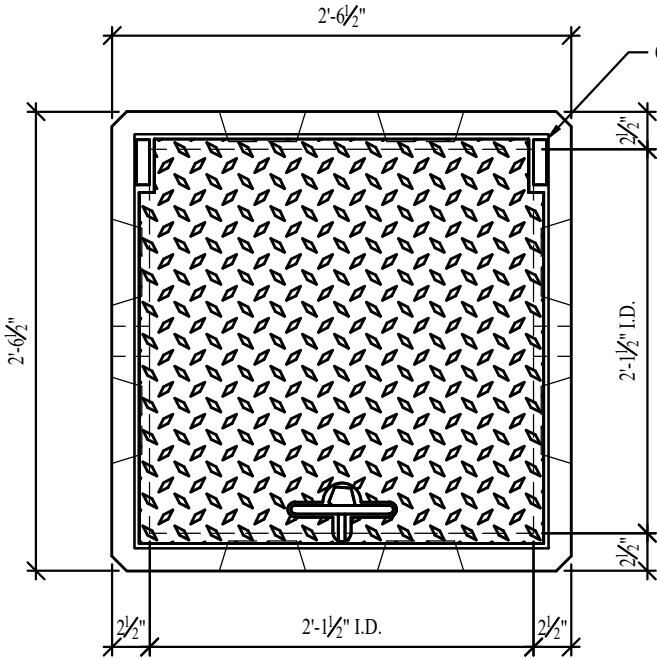

**PLAN VIEW**

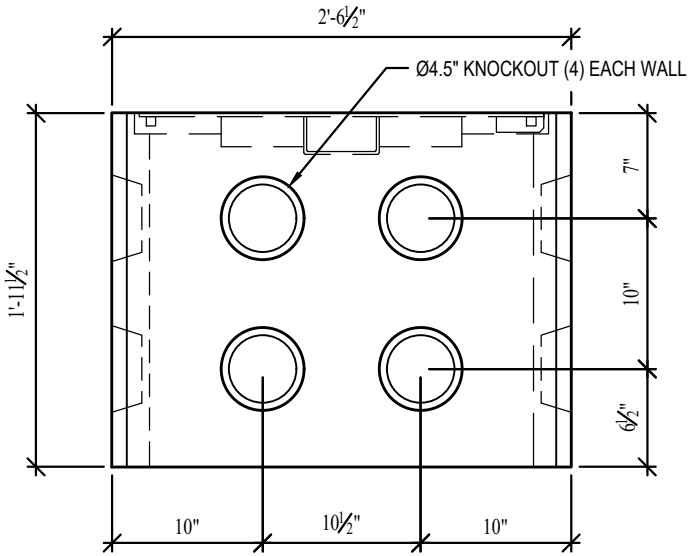
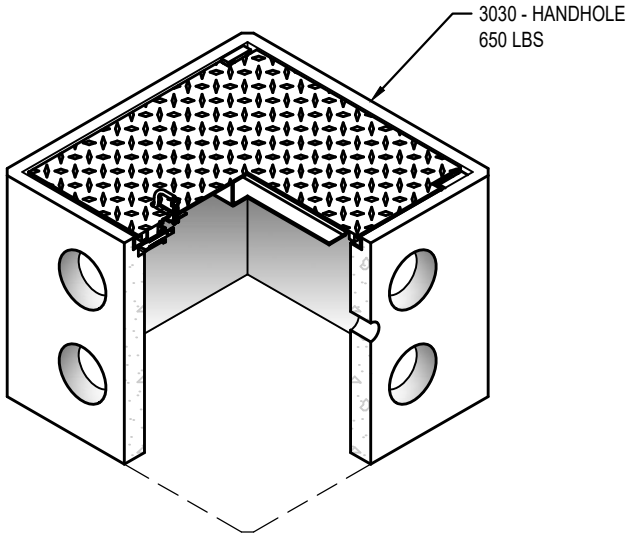

**SIDE VIEW**

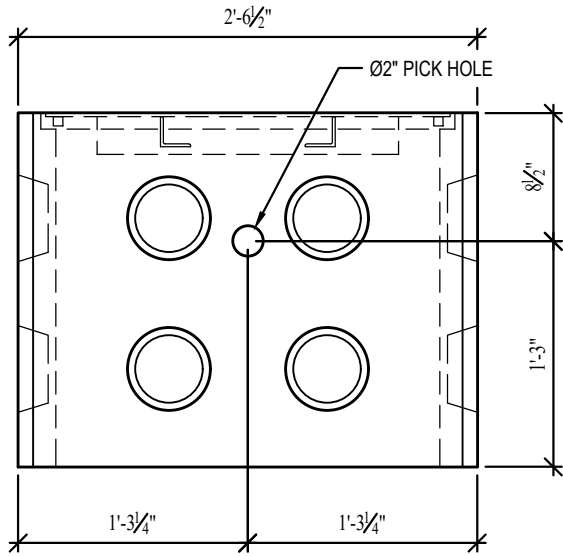

**END VIEW**