

3000 GALLON GREASE INTERCEPTOR (612)

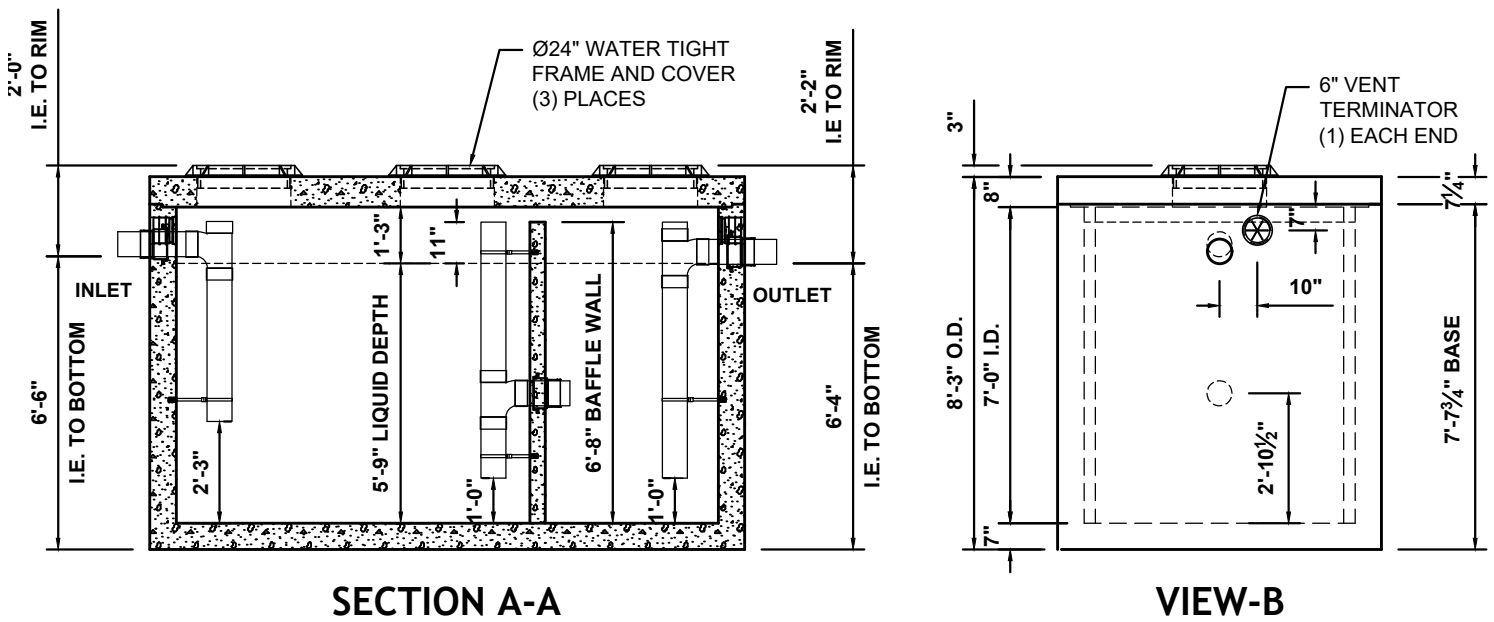

NOTES:

- Maximum DFU's = 372 for 3,000 gallon size Interceptor.
- Heaviest pick weight = approx. 33,820lbs.
- Vault meets or exceeds ASTM-C1613 & IAPMO/ANSI Z1001.
- H20 Traffic Rated.
- Fill completely with clean water prior to start-up of system.
- Gray water only.
- Ventilate Interceptor before servicing.
- It is the responsibility of the owner to service this unit.
- Interior plumbing included.
- Grade rings available as needed.

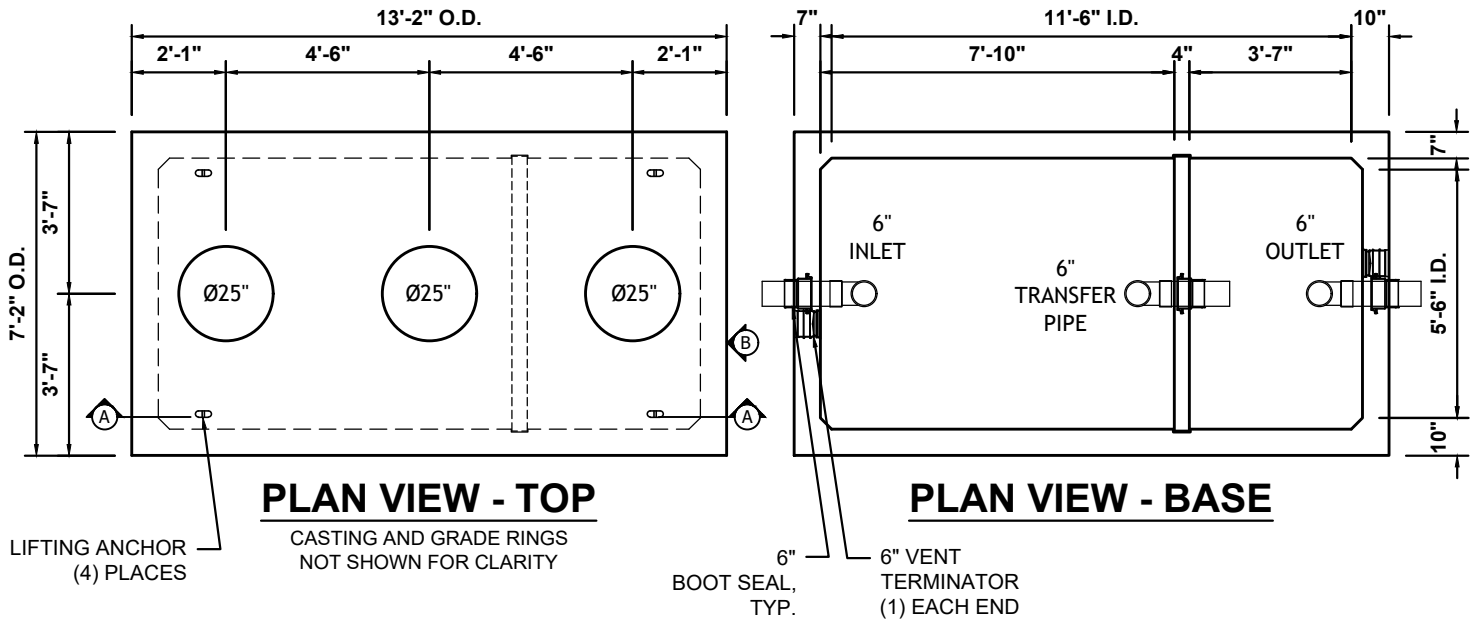

"IAPMO Listed"